

LX-PNADJ-WH - PNEUMATIC HEIGHT ADJUSTABLE LECTERN

Product Specifications:

Item Number	LX-PNADJ-WH
Dimensions	25.5"W x 17"D x 28"-42.5"H
Item Weight	23.1 lbs
Leg/Base Make	Powder Coated Steel
Base Dimensions	22"W x 17"D
Height Expansion Make	Aluminum
Tabletop Make	Medium Density Fiberboard (MDF) with Rubber Trim
Tabletop Dimensions	25.5"W x 16.7"D x 0.70" H
Tilt	4 Positions; 10°, 20°, 30°, 90°
Paper-Stop Lip	Yes
Height Adjustment Mechanism	Pneumatic Gas Foot Pedal
Height Adjustment Increments	Any Height Between 28"- 42.5" H
Weight Capacity	100 lbs.
Casters (2)	2" Casters, 2 Stationary Rubber Feet
Shipping Method	Ground
Shipping Carton Dims	34"W x 21"D x 5"H
Shipping Weight	27 lbs.
Assembly Required	Yes

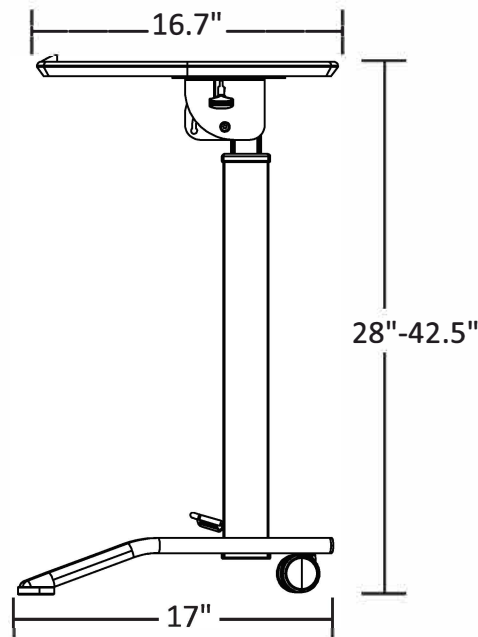

To Order, Call Your
Sales Representative
or 800-323-4656